

JOB NAME: _____

Date: _____

TYPE: _____

ST10 Series 8" 50W/42W/37W Intelligent Commercial Downlight

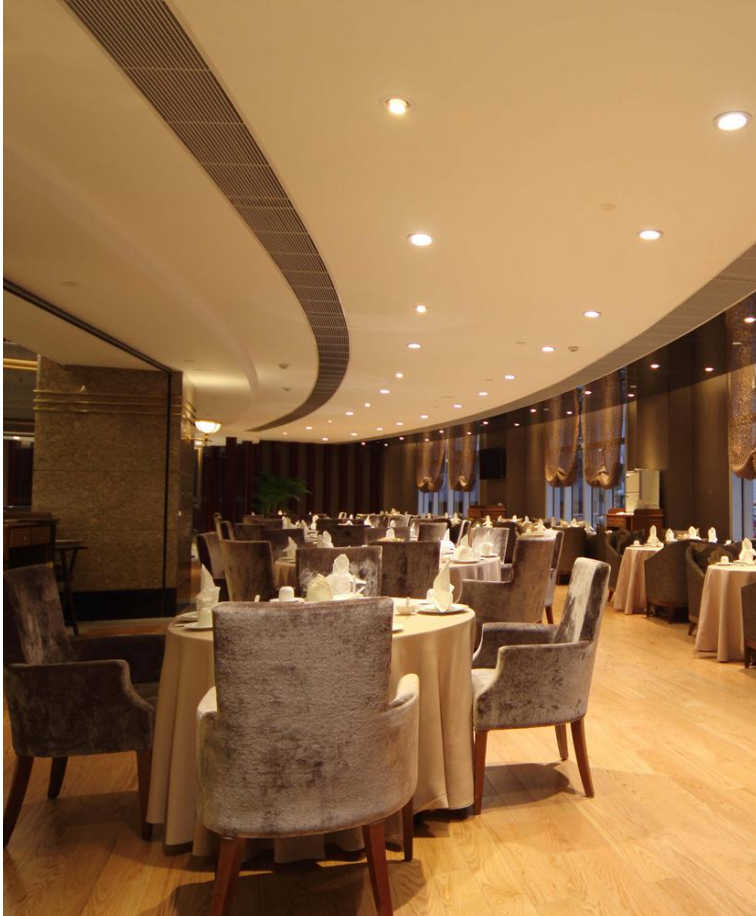

PRODUCT BENEFITS

- Color Selectable Switch: 4 color option Select from the warmest of whites to the coolest of whites.
- Adjust on Field: Three wattages to choose from. Select the power and brightness with a touch of a switch.
- IC Rated: For direct wire and ceiling installation.
- MC/BX Cable: Three feet with new innovated quick connect cable that twists and locks together.

PRODUCT FEATURES

- Easy & Fast install thanks to innovated design.
- Seperate J-box and wire for easy plug & play, connector box with push wire terminal for tool-free connection.
- CCT Selectable Options: 3500K-4000K-5000K.
- Wattage Selectable Options: 50W/42W/37W.
- 5 Years warranty.



JOB NAME: _____

Date: _____

TYPE: _____

PRODUCT DATASHEET

ELECTRICAL SPECIFICATIONS

Voltage:	AC 120-277V
Frequency:	50/60Hz
Wattages:	50W/42W/37W
Power Factor:	≥0.90
Input Current:	500mA/420mA/370mA
THD:	≤20%
Ripple Current:	≤5%
Frequency of LED current:	≥120Hz

LIGHTING SPECIFICATIONS

LUMENS:	4000 lm/3360 lm/2960 lm
Color:	3500K-4000K-5000K
Efficiency:	80 LPW
Ra:	≥90
R9:	≥0
SDCM:	≤6
Duv:	≤0.006
Beam Angle:	70°
Dimmable:	0-10V

OPERATION AND INFORMATION

Housing:	Aluminum Plate
Optical-Lens:	PC
Operating Temp:	-4°F ~ + 113°F
Storage Temp:	-22°F ~ + 149°F
Usage Environment:	Wet Location
Environment:	Indoor

SHIPPING

Product Net weight:	2.89lbs
Master Carton Size:	24.02" x 12.01" x17.32"
Quantity/Carton:	4pcs
Gross Weight:	17.64lbs
Pcs / Pallet:	120pcs
Pcs / 20' GP:	1368pcs (No Pallet) / 1200pcs (Palletized)
Pcs / 40' HQ:	3224pcs (No Pallet) / 2400pcs (Palletized)

CERTIFICATES

Standard:	UL,ES,CE,RoHS
Warranty:	5 years

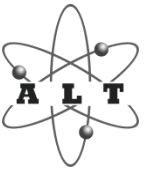

JOB NAME: _____

Date: _____

TYPE: _____

SPECIFICATIONS / ORDER INFO

SKU	Catalog Number	SIZE
LU10139-Z	ST10-50W-8NV-ZZK-C90-2	8"

LAMP CODE DEFINITIONS

Category	Wattage	Size	Voltage	CCT	CRI	Version
ST10=Series Number	50W/42W/37W	8=8"	NV=120-277V	ZZK=3 in 1 color	C90=90	2

SIZE CHART

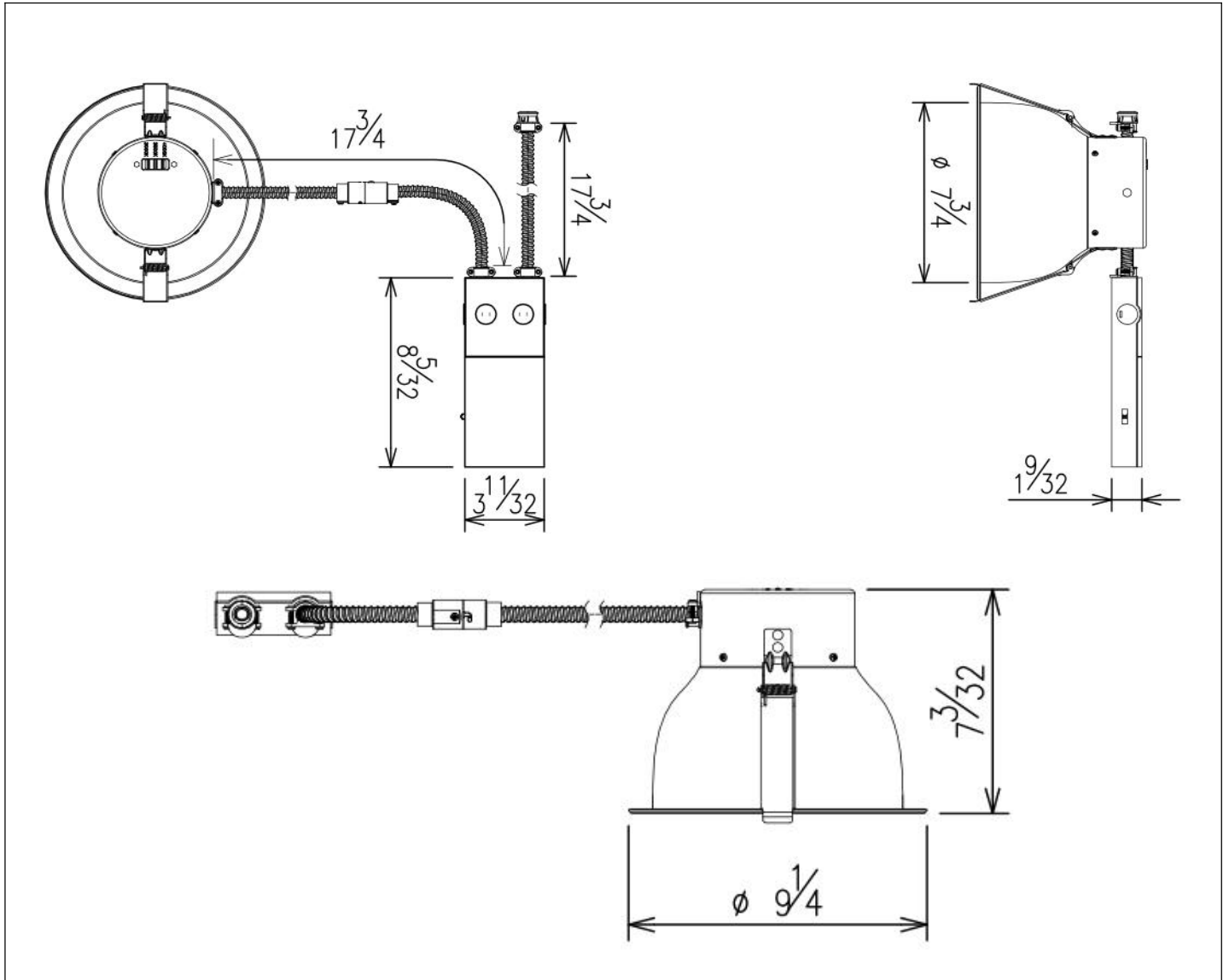



JOB NAME: _____

Date: _____

TYPE: _____

INSTALLATION DIAGRAM

1

Open junction box cover plate.

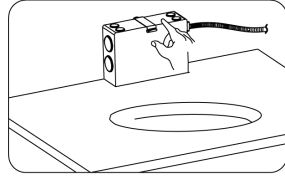

2

Put driver cable into junction box.

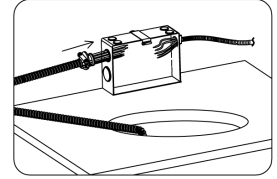

3

Close junction box cover plate after wires are properly connected.

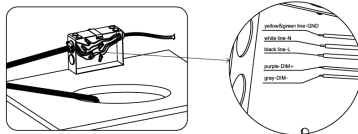

4

Connect the two cables together from lamp cable to driver cable.

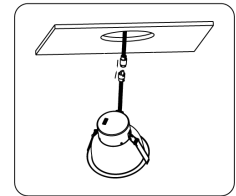

5

Connect wires then twist and lock the quick connector so it locks into place.

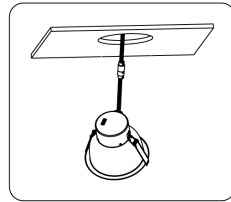

6

Hold springs in up right position then pass fixture through ceiling hole then release springs.

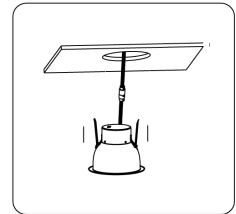

WIRING DIAGRAM





ENERGY STAR CERTIFIED Light Fixtures

ALT - LED Recessed Downlight : ST10-50W-8NV-ZZK-C90-1

Specifications

ENERGY STAR Unique ID:	2357832
ENERGY STAR Partner:	ALT
Brand Name:	ALT
Model Name:	LED Recessed Downlight
Model Number:	ST10-50W-8NV-ZZK-C90-1
Indoor/Outdoor:	Indoor
Fixture Type:	Downlight Recessed
Technology:	LED
Total Light Output (lumens):	4000
Appearance/Correlated Color Temperature (K):	4000/4100K,3000K,3500K
Total Input Power (Watts):	50.0
Color Quality (CRI):	91
Energy Efficiency - Measured Outside the Fixture (lumens/Watt):	80.0
Power Factor:	0.98
Light Source Life (hrs):	50000
Can Size(s):	8
Can Rating(s):	Type IC
Special Features:	Continuously Dimmable,Damp Location Rated,White Light Tunable
Light Source Connection/Base Type:	N/A
Date Available On Market:	2020-03-28
Date Certified:	2020-04-09
Markets:	United States, Canada
ENERGY STAR Certified:	Yes

Additional Model Information

,ST10-50W-8NV
-ZZK-C90-2,CCT
option: 3500K/4
000K/5000K

UPC Codes

Captured On:

12/21/2021