

JOB NAME: \_\_\_\_\_

Date: \_\_\_\_\_

TYPE: \_\_\_\_\_

## K14 Series 4" 8W 3in1 CCT Tunable Baffle Retrofit Trim



### PRODUCT BENEFITS

- Three light color in one luminaire:30K-40K-50K.
- Instant on.
- Easy fast install thanks to innovated design.
- 5 years warranty.

### PRODUCT FEATURES

- Three CCT light colors selectable via slide switch.
- Dim: Triac dimmable.
- Type of protection: Damp location.
- Connector box with push wire terminal for tool-free connection.
- Low profile luminaire can be installed.



JOB NAME: \_\_\_\_\_

Date: \_\_\_\_\_

TYPE: \_\_\_\_\_

## PRODUCT DATASHEET

### ELECTRICAL SPECIFICATIONS

<b>Voltage:</b>	AC 120V
<b>Frequency:</b>	60Hz
<b>Wattages:</b>	8W
<b>Power Factor:</b>	≥0.90
<b>Input Current:</b>	80mA
<b>THD:</b>	≤20%
<b>Ripple Current:</b>	≤5%
<b>Frequency of LED current:</b>	≥120Hz

### LIGHTING SPECIFICATIONS

<b>LUMENS:</b>	720 lm
<b>Color:</b>	3000K-4000K-5000K
<b>Efficiency:</b>	90 LPW
<b>Ra:</b>	≥92
<b>R9:</b>	≥0
<b>SDCM:</b>	≤6
<b>Duv:</b>	≤0.006
<b>Beam Angle:</b>	100°
<b>Dimmable:</b>	Triac dimmable

### OPERATION AND INFORMATION

<b>Housing:</b>	Aluminum
<b>Optical-Lens:</b>	PC
<b>Operating Temp:</b>	-4°F ~ + 113°F
<b>Storage Temp:</b>	-22°F ~ + 149°F
<b>Usage Environment:</b>	Damp Location
<b>Environment:</b>	Indoor

### SHIPPING

<b>Product Net weight:</b>	0.32lbs
<b>Master Carton Size:</b>	22.24" x 17.72" x17.32"
<b>Quantity/Carton:</b>	60pcs
<b>Gross Weight:</b>	28.66lbs
<b>Pcs / Pallet:</b>	1200pcs
<b>Pcs / 20' GP:</b>	15600pcs (No Pallet) / 12000pcs (Palletized)
<b>Pcs / 40' HQ:</b>	37440pcs (No Pallet) / 24000pcs (Palletized)

### CERTIFICATES

<b>Standard:</b>	ETL,ES,CE,RoHS
<b>Warranty:</b>	5 years



JOB NAME: \_\_\_\_\_

Date: \_\_\_\_\_

TYPE: \_\_\_\_\_

### SPECIFICATIONS / ORDER INFO

SKU	Catalog Number	SIZE
LU10067-Z	K14-8W-4CT-ZZK-LR-BK	4"

### LAMP CODE DEFINITIONS

Category	Wattage	Size	Voltage	CCT	Shape	Color
K14=Series Number	8W	4=4"	CT=120V	ZZK=3 in 1 color	LR=Round	BK=Black

### SIZE CHART

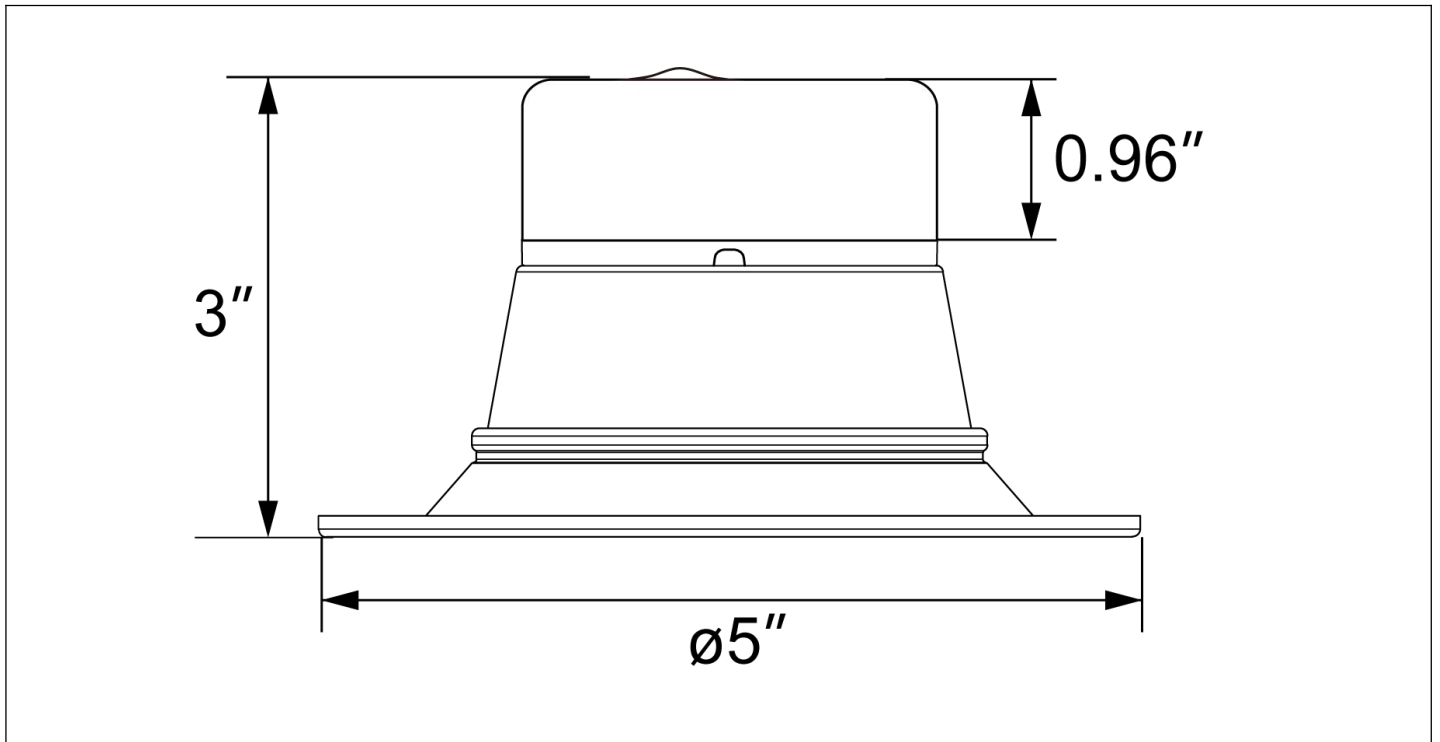



# ENERGY STAR CERTIFIED Light Fixtures

## ALT - SSL downlight retrofit : K14-8W-4CT-ZZK-LR-\*\*

### Specifications

ENERGY STAR Unique ID:	2352063
ENERGY STAR Partner:	ALT
Brand Name:	ALT
Model Name:	SSL downlight retrofit
Model Number:	K14-8W-4CT-ZZK-LR-**
Indoor/Outdoor:	Indoor
Fixture Type:	Downlight Solid State Retrofit
Technology:	LED
Total Light Output (lumens):	560
Appearance/Correlated Color Temperature (K):	2700K
Total Input Power (Watts):	8.0
Color Quality (CRI):	92
Energy Efficiency - Measured Outside the Fixture (lumens/Watt):	70.0
Power Factor:	0.9
Light Source Life (hrs):	50000
Special Features:	Continuously Dimmable,Damp Location Rated
Light Source Connection/Base Type:	N/A
Date Available On Market:	2019-11-13
Date Certified:	2019-12-23
Markets:	United States, Canada
ENERGY STAR Certified:	Yes

### Additional Model Information

„\*\*“ represents enclosure color, it can be WH=W hite, BK=Black, BR=Bronze, BN=Brushed Nickel.

UPC Codes

Captured On:  
12/21/2021