



SURFACE MOUNT KIT

Surface Mount Kit | Accessories

SKU

53-2092A	1X4 SURFACE MOUNT KIT
53-2090A	2X2 SURFACE MOUNT KIT
53-2091A	2X4 SURFACE MOUNT KIT

DESCRIPTION

This Specification-grade recessed flange kit is designed for The most common T-grid LED luminaires to recessed mounting Installation into drywall ceilings. The drywall flange kit is extruded Aluminum construction with mitered corners with screws for Complete assembly. This flange mounting kit is fully painted, Inside and out, in a white color and is constructed using aluminum Alloy 6063 that is ideal for offices, schools, hospitals and medical Facility applications where installation is required in drywall recessed.

FEATURE

- Heavy-duty construction
- Universal - fits most manufacturer's T-grid luminaires.
- White powder painted.
- Easy to install.

APPLICATION

Recessed mounting kit for drywall ceilings.

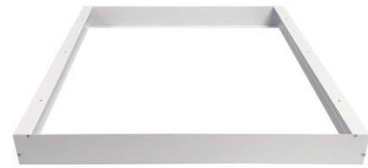



SURFACE MOUNT **KIT**

Surface Mount Kit | Accessories

DIMENSIONS & CEILING OPENING

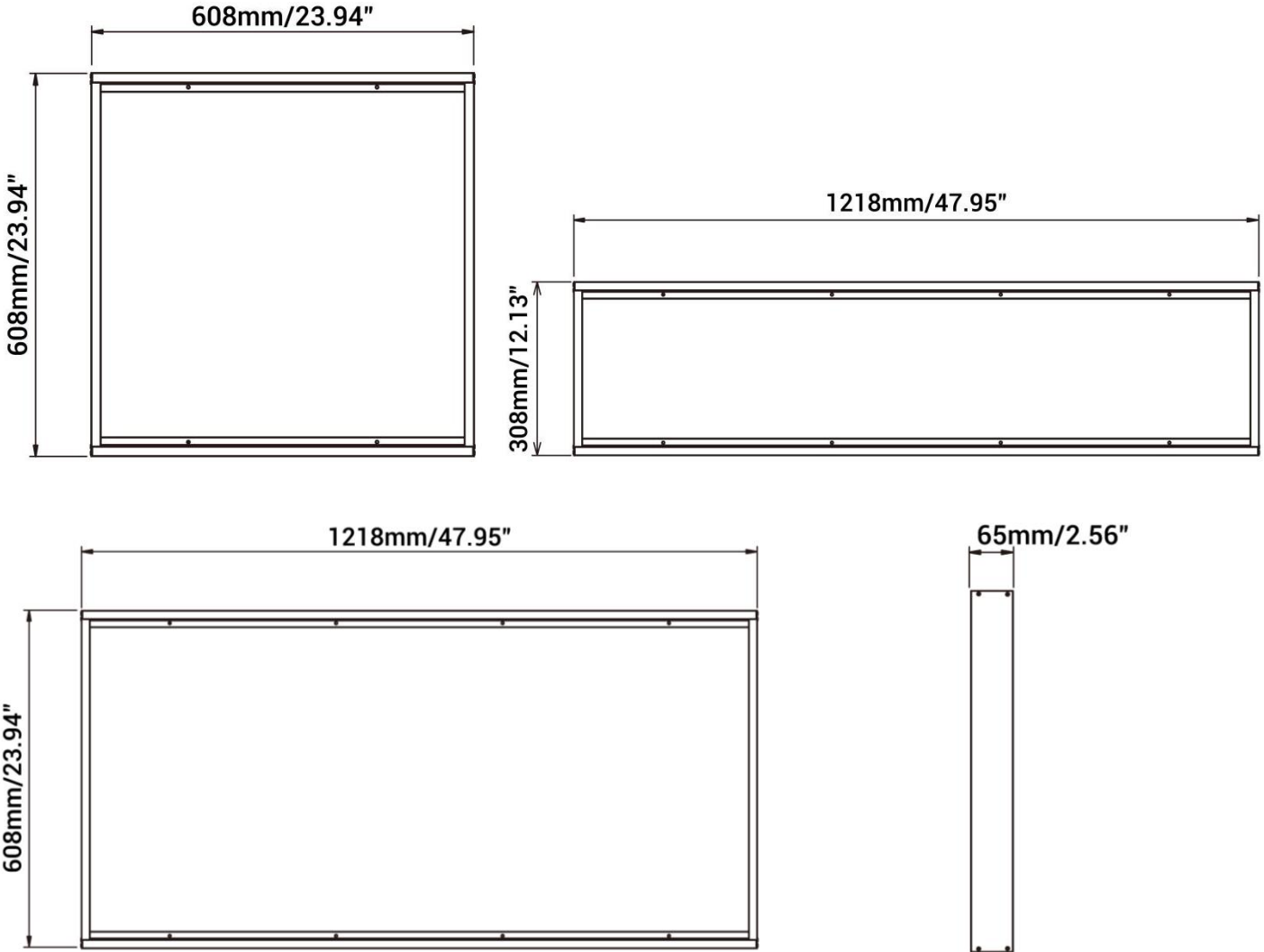



SURFACE MOUNT **KIT**

Surface Mount Kit | Accessories

PACKAGE

SKU	Size	Length	Width	Height	Pcs / Carton	Net Weight	Gross Weight
53-2090A	2' x 2'	24.8"	9.06"	10.24"	20	1.31	27.43
53-2092A	1' x 4'	48.43"	8.86"	10.24"	20	1.84	39.51
53-2091A	2' x 4'	48.43"	8.86"	10.24"	20	2.2	43.06

Installation Instruction

Surface Mounting Kit

1

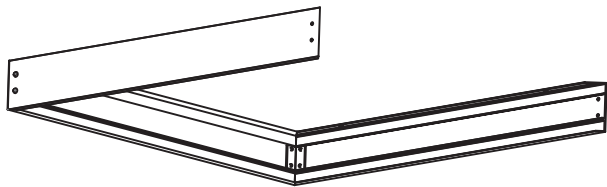

Using the appropriate dimensions and fasteners after properly measuring the placement of the surface mount frame.

2

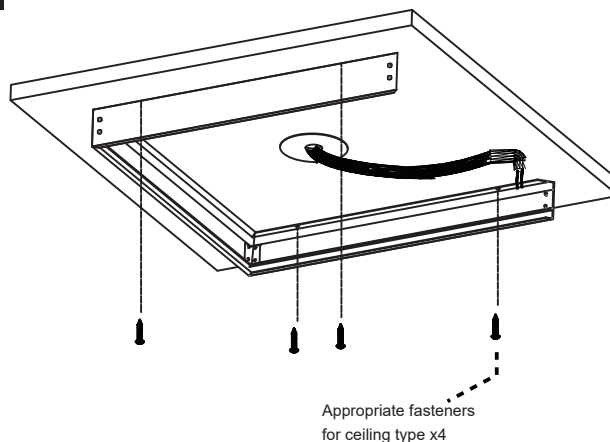

Choose the opening part as close as possible to the junction box prior to securing the surface mount frame to the ceiling. Ensure the frame is square, then slide horizontally till the end of slots prior to fully securing the frame to the ceiling.

3

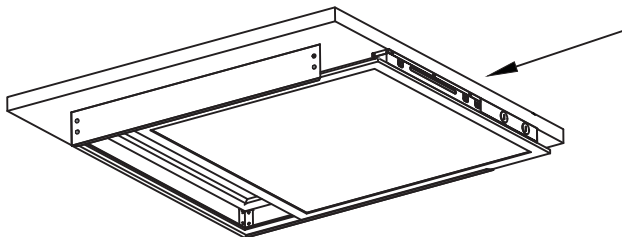

Put the wire conduit hose as close as possible to the surface mount opening before placing/inserting the luminaire into it partially. Make all electrical connections according to local code and make sure wire conduit hose is long enough for wiring connection job.

4

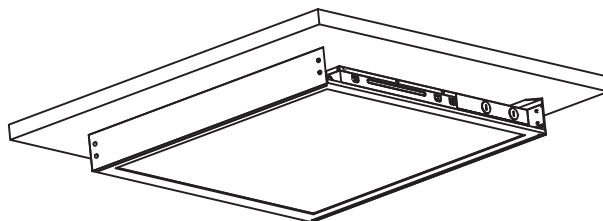

Push the conduit hose back into the surface mount frame properly, insert the luminaire fully into the frame. When installed properly, the luminaire will rest on the flanges of the surface mount frames. If the luminaire is not resting properly on the flanges, lift it up and shift it until it rests into place.

5

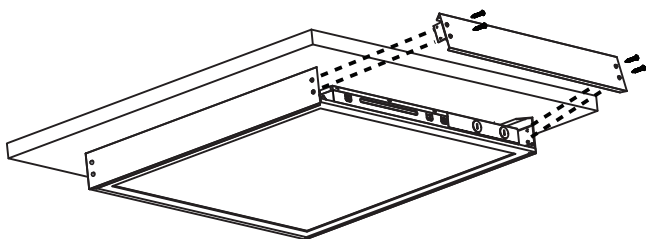

Place the last frame into the slots, Fix the side frame by screw. make sure it get locked tightly, join the last frame to the rested frames by fastening them together with appropriate fasteners.

6

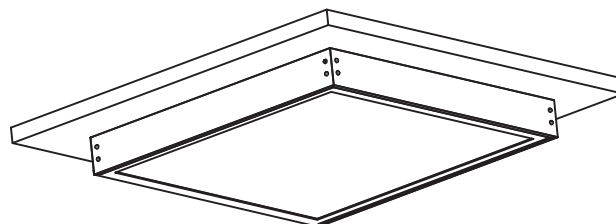

Installation completed. Fixture is ready to power on.