

Flange Kit | Accessories

SKU

53-2095F	1X4 FLANG KIT
53-2093F	2X2 FLANG KIT
53-2094F	2X4 FLANG KIT

DESCRIPTION

This Specification-grade recessed flange kit is designed for The most common T-grid LED luminaires to recessed mounting Installation into drywall ceilings. The drywall flange kit is extruded Aluminum construction with mitered corners with screws for Complete assembly. This flange mounting kit is fully painted, Inside and out, in a white color and is constructed using aluminum Alloy 6063 that is ideal for offices, schools, hospitals and medical Facility applications where installation is required in drywall recessed.

FEATURE

- Heavy-duty construction
- Universal - fits most manufacturer's T-grid luminaires.
- White powder painted.
- Easy to install.

APPLICATION

Recessed mounting kit for drywall ceilings.



Flange Kit | Accessories

DIMENSIONS & CEILING OPENING

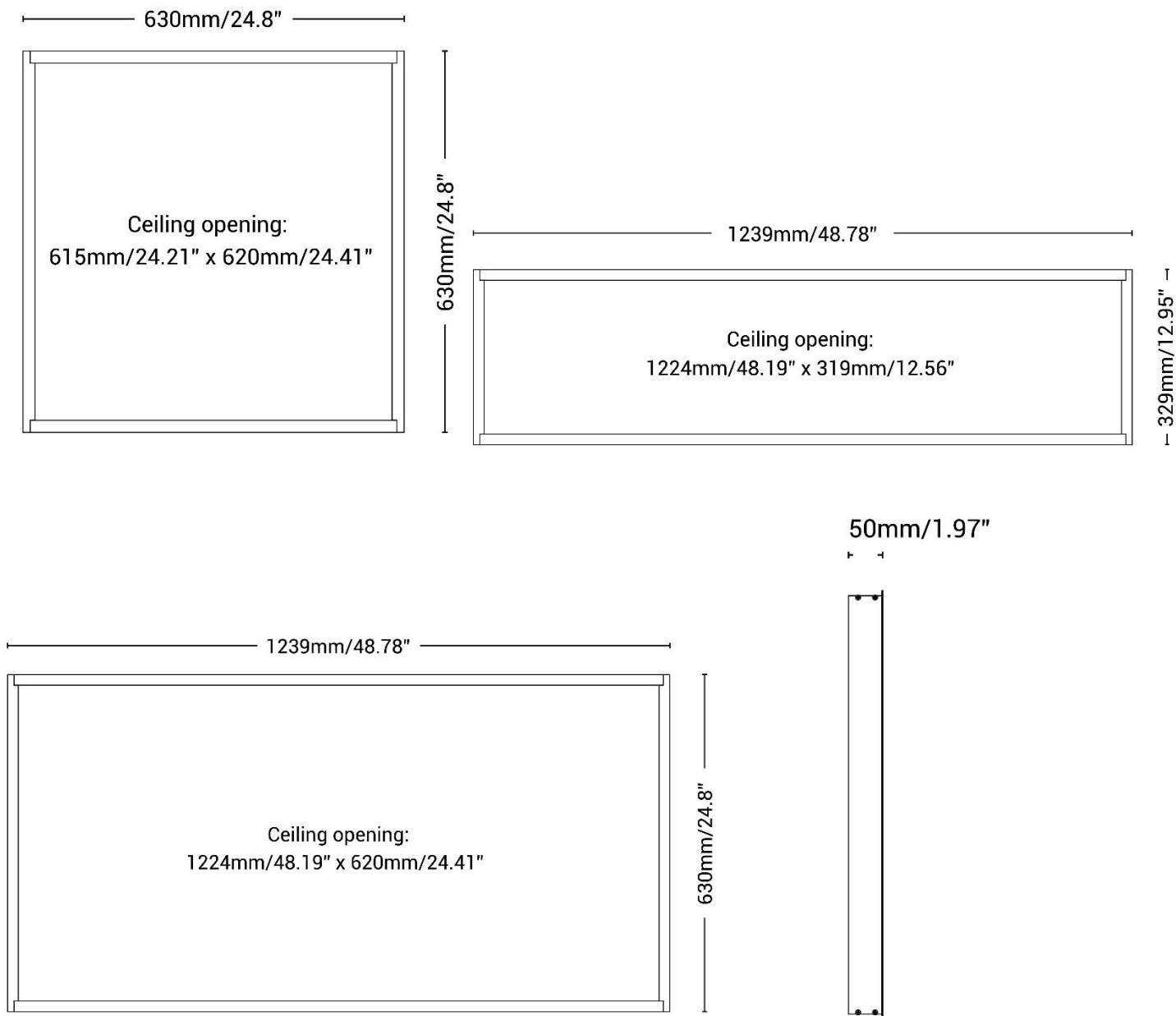

FLANGE KIT

INSTALL INSTRUCTIONS

PLEASE FIND A QUALIFIED ELECTRICIAN FOR INSTALLATION. Please read the instructions before you install and use the luminaire.

WARNING, CAUTIONS AND OPERATING INSTRUCTIONS

- Turn circuit breaker(s) off or remove fuse(s) before installation.
- Kits must be installed in accordance with all local codes and ordinances.

SAFETY INFORMATION - TO REDUCE THE RISK OF FIRE, OR INJURY TO PERSONS:

- Suitable for installation in sheet rock / plasterboard in both insulated ceilings and non-insulated ceilings. Not for continuous row mounting.
- Do not handle powered fixtures when hands are wet or standing on damp or wet surfaces.
- Vapor barrier must be suitable for 90°C.
- Flange kit to be independently supported to building structure.
- Suitable for damp locations.
- Suitable only for Indoor Recessed Ceiling application.

SAVE THESE INSTRUCTION

! WARNING DISCONNECT POWER BEFORE INSTALLING OR SERVICING.

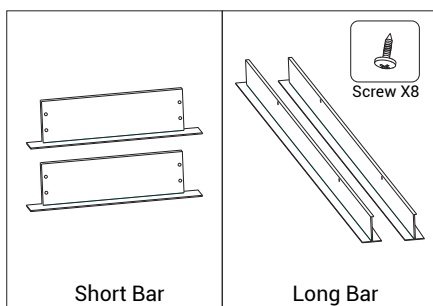

DESCRIPTION	CEILING OPENING(inch)
1X4 FLANGE KIT	48.19" X 12.56"
2X2 FLANGE KIT	24.21" X 24.41"
2X4 FLANGE KIT	48.19" X 24.41"

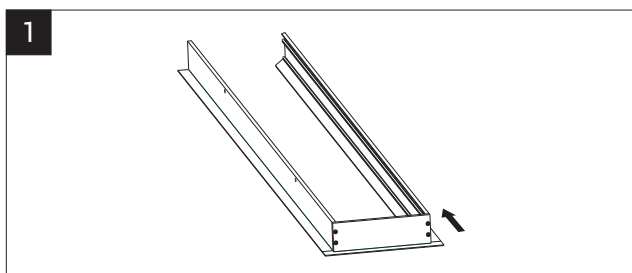

Join the 2pcs long bars and 1pc short bar together with screws.

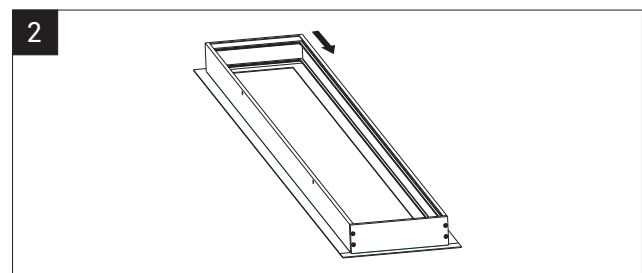

Then join these 2pcs long bars and another short bar together with screws.

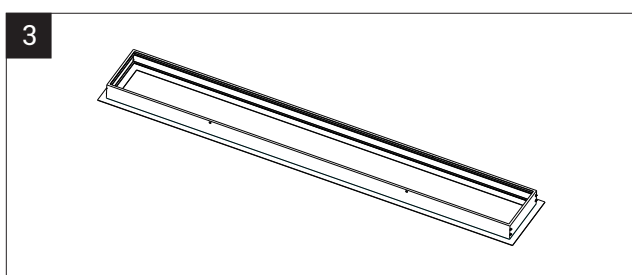

Assembly complete

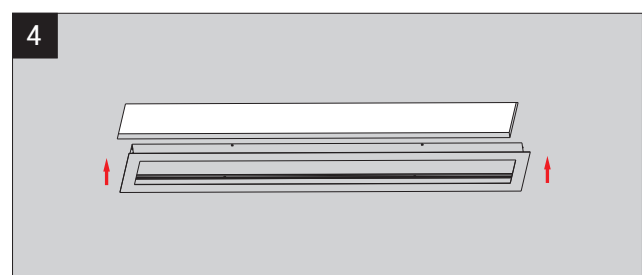

Embed this flange kit through the ceiling opening

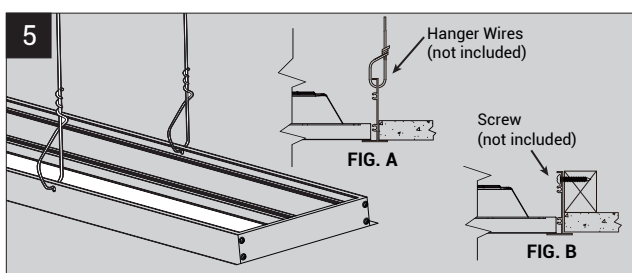

Secure the Flange Kit to the building structure by Hanger Wires(not included) (Fig. A), alternatively screw(not included) to Wood Blocking (Fig. B).

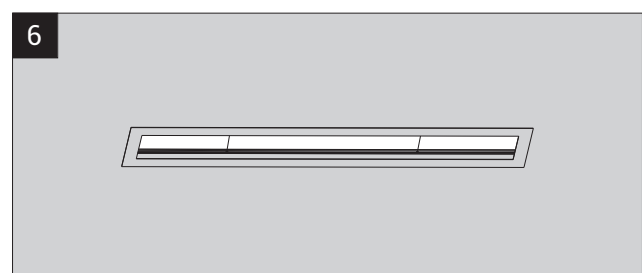

Suspend the flange kit to level with the ceiling, installation complete.